

LM5106

100V Half Bridge Gate Driver with Programmable Dead-Time

General Description

The LM5106 is a high voltage gate driver designed to drive both the high side and low side N-Channel MOSFETs in a synchronous buck or half bridge configuration. The floating high side driver is capable of working with rail voltages up to 100V. The single control input is compatible with TTL signal levels and a single external resistor programs the switching transition dead-time through tightly matched turn-on delay circuits. The robust level shift technology operates at high speed while consuming low power and provides clean output transitions. Under-voltage lockout disables the gate driver when either the low side or the bootstrapped high side supply voltage is below the operating threshold. The LM5106 is offered in the MSOP-10 or thermally enhanced 10-pin LLP plastic package.

Features

- Drives both a high side and low side N-channel MOSFET
- 1.8A peak output sink current

- 1.2A peak output source current
- Bootstrap supply voltage range up to 118V DC
- Single TTL compatible Input
- Programmable turn-on delays (Dead-time)
- Enable Input pin
- Fast turn-off propagation delays (32ns typical)
- Drives 1000pF with 15ns rise and 10ns fall time
- Supply rail under-voltage lockout
- Low power consumption

Typical Applications

- Solid State motor drives
- Half and Full Bridge power converters
- Two switch forward power converters

Package

- LLP-10 (4 mm x 4 mm)
- MSOP-10

Simplified Block Diagram

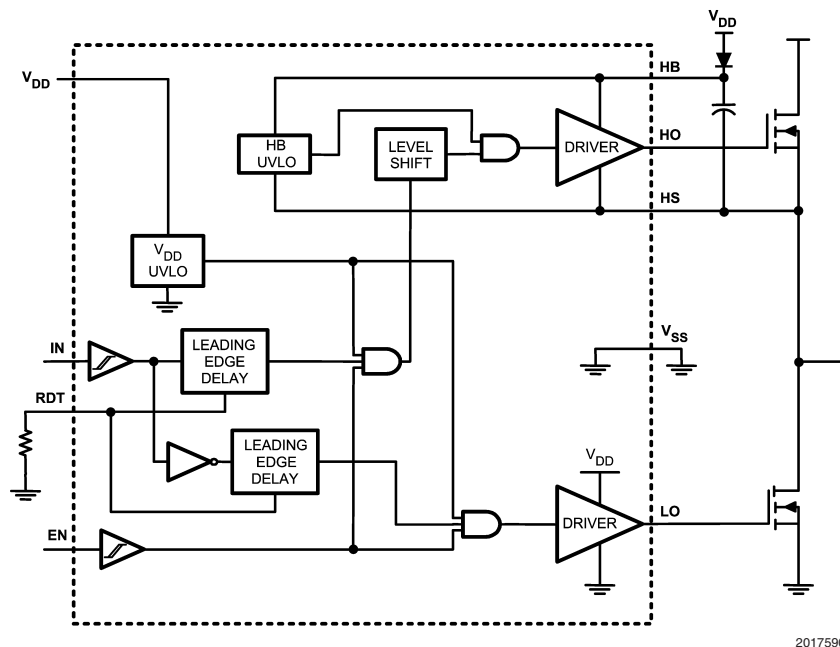
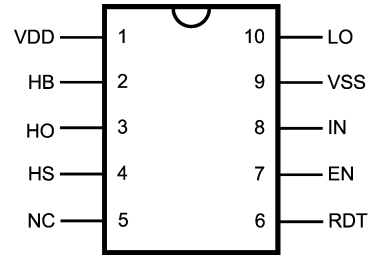

FIGURE 1.

Connection Diagram



20175901

10-Lead MSOP or LLP
See NS Number MUB10A, SDC10A

Ordering Information

Ordering Number	Package Type	NSC Package Drawing	Supplied As
LM5106MM	MSOP-10	MUB10A	1000 shipped as Tape & Reel
LM5106MMX	MSOP-10	MUB10A	3500 shipped as Tape & Reel
LM5106SD	LLP-10	SDC10A	1000 shipped as Tape & Reel
LM5106SDX	LLP-10	SDC10A	4500 shipped as Tape & Reel

Pin Descriptions

Pin	Name	Description	Application Information
1	VDD	Positive gate drive supply	Decouple VDD to VSS using a low ESR/ESL capacitor, placed as close to the IC as possible.
2	HB	High side gate driver bootstrap rail	Connect the positive terminal of bootstrap capacitor to the HB pin and connect negative terminal to HS. The Bootstrap capacitor should be placed as close to IC as possible.
3	HO	High side gate driver output	Connect to the gate of high side N-MOS device through a short, low inductance path.
4	HS	High side MOSFET source connection	Connect to the negative terminal of the bootstrap capacitor and to the source of the high side N-MOS device.
5	NC	Not Connected	
6	RDT	Dead-time programming pin	A resistor from RDT to VSS programs the turn-on delay of both the high and low side MOSFETs. The resistor should be placed close to the IC to minimize noise coupling from adjacent PC board traces.
7	EN	Logic input for driver Disable/Enable	TTL compatible threshold with hysteresis. LO and HO are held in the low state when EN is low.
8	IN	Logic input for gate driver	TTL compatible threshold with hysteresis. The high side MOSFET is turned on and the low side MOSFET turned off when IN is high.
9	VSS	Ground return	All signals are referenced to this ground.
10	LO	Low side gate driver output	Connect to the gate of the low side N-MOS device with a short, low inductance path.
NA	EP	Exposed Pad	The exposed pad has no electrical contact. Connect to system ground plane for reduced thermal resistance.

Absolute Maximum Ratings (Note 1)

If Military/Aerospace specified devices are required, please contact the National Semiconductor Sales Office/Distributors for availability and specifications.

V_{DD} to V_{SS}	-0.3V to +18V
HB to HS	-0.3V to +18V
IN and EN to V_{SS}	-0.3V to $V_{DD} + 0.3V$
LO to V_{SS}	-0.3V to $V_{DD} + 0.3V$
HO to V_{SS}	HS - 0.3V to HB + 0.3V
HS to V_{SS} (Note 6)	-5V to +100V
HB to V_{SS}	118V
RDT to V_{SS}	-0.3V to 5V
Junction Temperature	+150°C

Storage Temperature Range -55°C to +150°C

ESD Rating HBM 1.5 kV
(Note 2)**Recommended Operating Conditions**

V_{DD}	+8V to +14V
HS (Note 6)	-1V to 100V
HB	HS + 8V to HS + 14V
HS Slew Rate	<50V/ns
Junction Temperature	-40°C to +125°C

Electrical Characteristics Specifications in standard typeface are for $T_J = +25^\circ\text{C}$, and those in **boldface type** apply over the full **operating junction temperature range**. Unless otherwise specified, $V_{DD} = \text{HB} = 12\text{V}$, $V_{SS} = \text{HS} = 0\text{V}$, $\text{EN} = 5\text{V}$. No load on LO or HO. RDT= 100k Ω (Note 4).

Symbol	Parameter	Conditions	Min	Typ	Max	Units
SUPPLY CURRENTS						
I_{DD}	V_{DD} Quiescent Current	IN = EN = 0V		0.34	0.6	mA
I_{DDO}	V_{DD} Operating Current	f = 500 kHz		2.1	3.5	mA
I_{HB}	Total HB Quiescent Current	IN = EN = 0V		0.06	0.2	mA
I_{HBO}	Total HB Operating Current	f = 500 kHz		1.5	3	mA
I_{HBS}	HB to V_{SS} Current, Quiescent	HS = HB = 100V		0.1	10	μA
I_{HBSO}	HB to V_{SS} Current, Operating	f = 500 kHz		0.5		mA
INPUT IN and EN						
V_{IL}	Low Level Input Voltage Threshold		0.8	1.8		V
V_{IH}	High Level Input Voltage Threshold			1.8	2.2	V
R_{pd}	Input Pulldown Resistance Pin IN and EN		100	200	500	k Ω
DEAD-TIME CONTROLS						
VRDT	Nominal Voltage at RDT		2.7	3	3.3	V
IRDT	RDT Pin Current Limit	RDT = 0V	0.75	1.5	2.25	mA
UNDER VOLTAGE PROTECTION						
V_{DDR}	V_{DD} Rising Threshold		6.2	6.9	7.6	V
V_{DDH}	V_{DD} Threshold Hysteresis			0.5		V
V_{HBR}	HB Rising Threshold		5.9	6.6	7.3	V
V_{HBH}	HB Threshold Hysteresis			0.4		V
LO GATE DRIVER						
V_{OLL}	Low-Level Output Voltage	$I_{LO} = 100\text{ mA}$		0.21	0.4	V
V_{OHL}	High-Level Output Voltage	$I_{LO} = -100\text{ mA}$, $V_{OHL} = V_{DD} - V_{LO}$		0.5	0.85	V
I_{OHL}	Peak Pullup Current	LO = 0V		1.2		A
I_{OLL}	Peak Pulldown Current	LO = 12V		1.8		A
HO GATE DRIVER						
V_{OLH}	Low-Level Output Voltage	$I_{HO} = 100\text{ mA}$		0.21	0.4	V
V_{OHH}	High-Level Output Voltage	$I_{HO} = -100\text{ mA}$, $V_{OHH} = \text{HB} - \text{HO}$		0.5	0.85	V
I_{OHH}	Peak Pullup Current	HO = 0V		1.2		A
I_{OLH}	Peak Pulldown Current	HO = 12V		1.8		A
THERMAL RESISTANCE						
θ_{JA}	Junction to Ambient	(Note 3), (Note 5)		40		$^\circ\text{C/W}$

Switching Characteristics Specifications in standard typeface are for $T_J = +25^\circ\text{C}$, and those in **boldface type** apply over the full **operating junction temperature range**. Unless otherwise specified, $V_{DD} = \text{HB} = 12\text{V}$, $V_{SS} = \text{HS} = 0\text{V}$, No Load on LO or HO (Note 4).

Symbol	Parameter	Conditions	Min	Typ	Max	Units
t_{LPHL}	Lower Turn-Off Propagation Delay			32	56	ns
t_{HPHL}	Upper Turn-Off Propagation Delay			32	56	ns
t_{LPLH}	Lower Turn-On Propagation Delay	RDT = 100k	400	520	640	ns
t_{HPLH}	Upper Turn-On Propagation Delay	RDT = 100k	450	570	690	ns
t_{LPLH}	Lower Turn-On Propagation Delay	RDT = 10k	85	115	160	ns
t_{HPLH}	Upper Turn-On Propagation Delay	RDT = 10k	85	115	160	ns
t_{en}, t_{sd}	Enable and Shutdown propagation delay			36		ns
DT1, DT2	Dead-time LO OFF to HO ON & HO OFF to LO ON	RDT = 100k		510		μs
		RDT = 10k		86		ns
MDT	Dead-time matching	RDT = 100k		50		ns
t_R	Either Output Rise Time	$C_L = 1000\text{pF}$		15		ns
t_F	Either Output Fall Time	$C_L = 1000\text{pF}$		10		ns

Note 1: Absolute Maximum Ratings indicate limits beyond which damage to the component may occur. Operating Ratings are conditions under which operation of the device is guaranteed. Operating Ratings do not imply guaranteed performance limits. For guaranteed performance limits and associated test conditions, see the Electrical Characteristics tables.

Note 2: The human body model is a 100 pF capacitor discharged through a 1.5k Ω resistor into each pin. Pin 2, Pin 3 and Pin 4 are rated at 500V.

Note 3: 4 layer board with Cu finished thickness 1.5/1.0/1.0/1.5 oz. Maximum die size used. 5x body length of Cu trace on PCB top. 50 x 50mm ground and power planes embedded in PCB. See Application Note AN-1187.

Note 4: Min and Max limits are 100% production tested at 25°C. Limits over the operating temperature range are guaranteed through correlation using Statistical Quality Control (SQC) methods. Limits are used to calculate National's Average Outgoing Quality Level (AOQL).

Note 5: The θ_{JA} is not a constant for the package and depends on the printed circuit board design and the operating conditions.

Note 6: In the application the HS node is clamped by the body diode of the external lower N-MOSFET, therefore the HS voltage will generally not exceed -1V. However in some applications, board resistance and inductance may result in the HS node exceeding this stated voltage transiently.

If negative transients occur on HS, the HS voltage must never be more negative than $V_{DD} - 15\text{V}$. For example, if $V_{DD} = 10\text{V}$, the negative transients at HS must not exceed -5V.

Typical Performance Characteristics

V_{DD} Operating Current vs Frequency

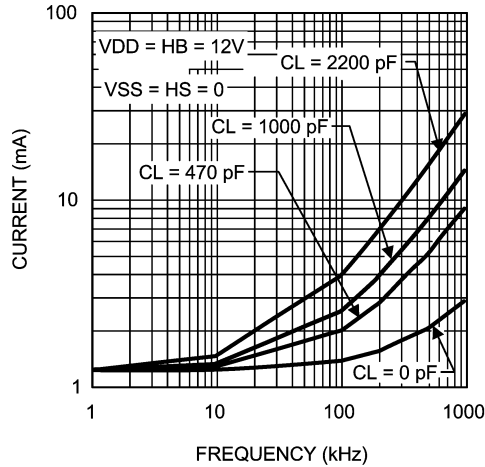

20175910

Operating Current vs Temperature

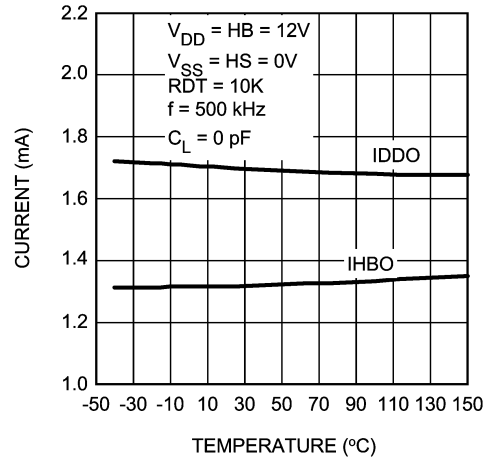

20175911

Quiescent Current vs Supply Voltage

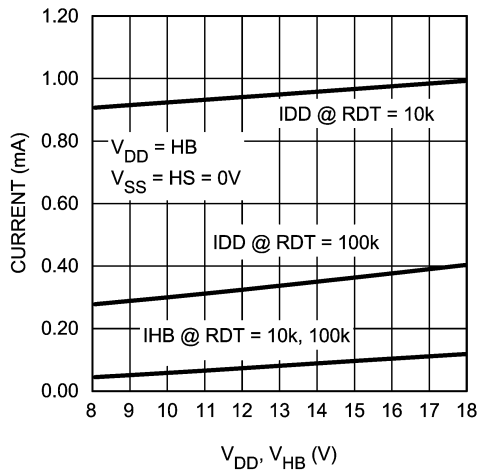

20175912

Quiescent Current vs Temperature

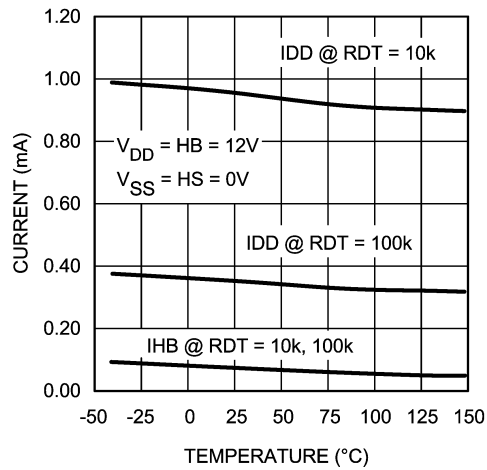

20175913

HB Operating Current vs Frequency

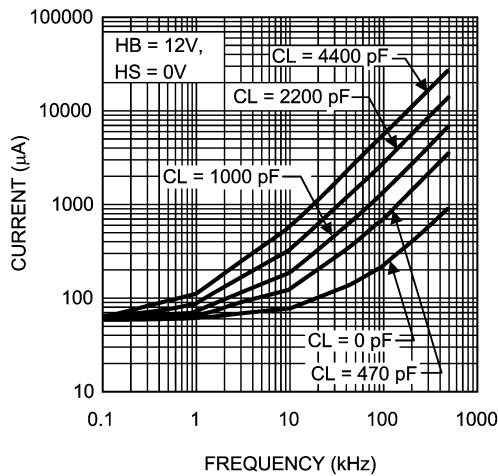

20175916

HO & LO Peak Output Current vs Output Voltage

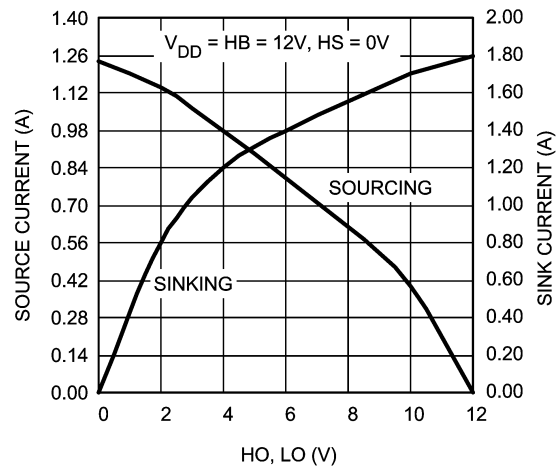

20175917

Typical Performance Characteristics (Continued)

Undervoltage Rising Threshold vs Temperature

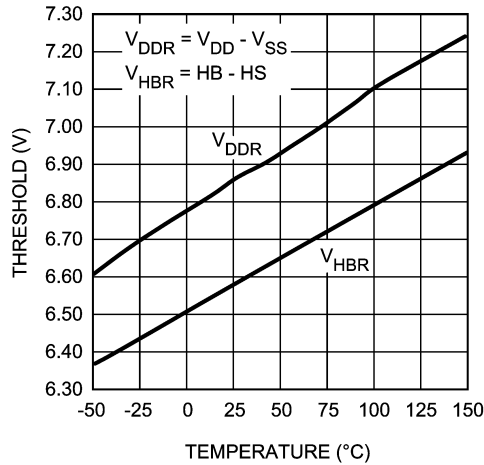

20175919

Undervoltage Hysteresis vs Temperature

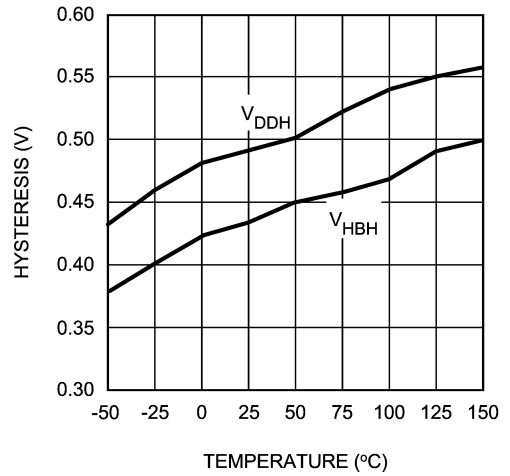

20175918

LO & HO - Low Level Output Voltage vs Temperature

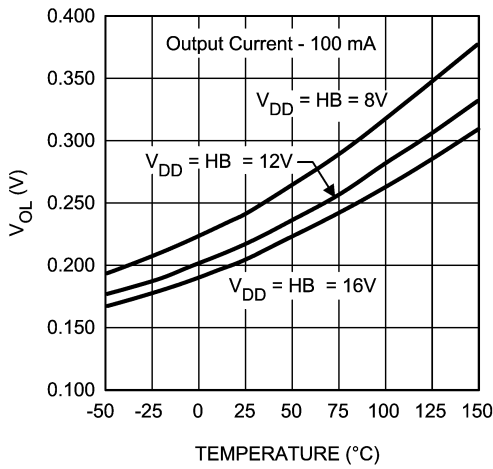

20175921

LO & HO - High Level Output Voltage vs Temperature

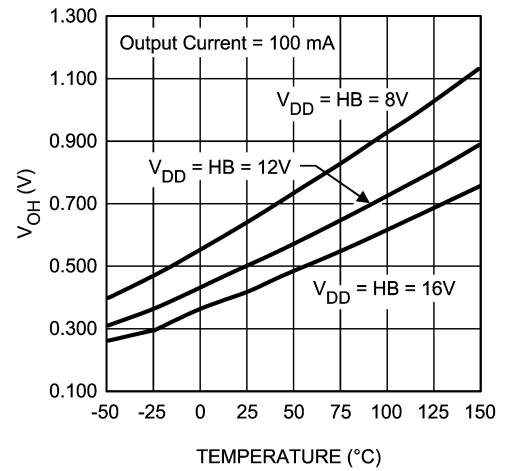

20175920

Input Threshold vs Temperature

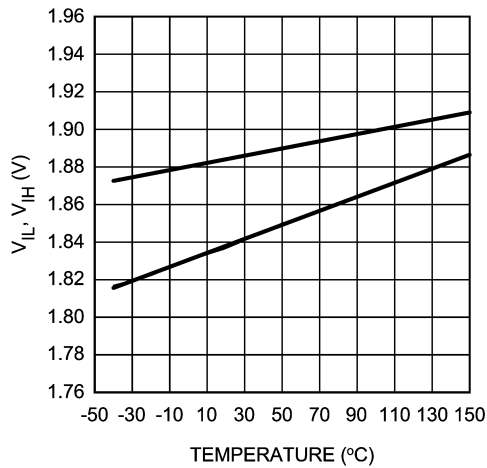

20175922

Dead-Time vs RT Resistor Value

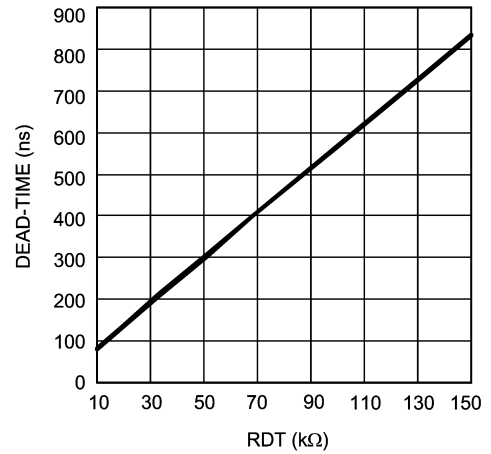

20175914

Typical Performance Characteristics (Continued)

Dead-Time vs Temperature (RT = 10k)

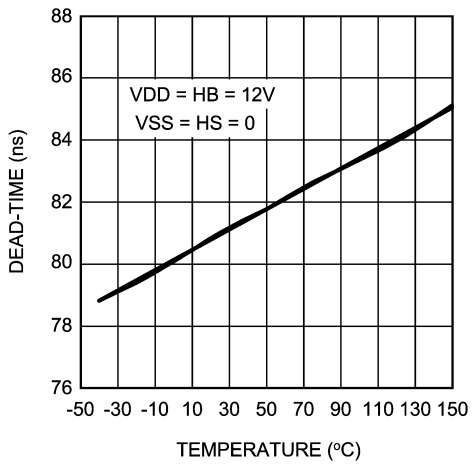

20175926

Dead-Time vs Temperature (RT = 100k)

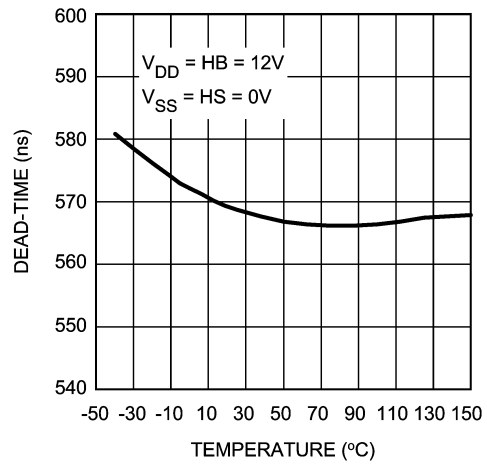

20175927

Timing Diagrams

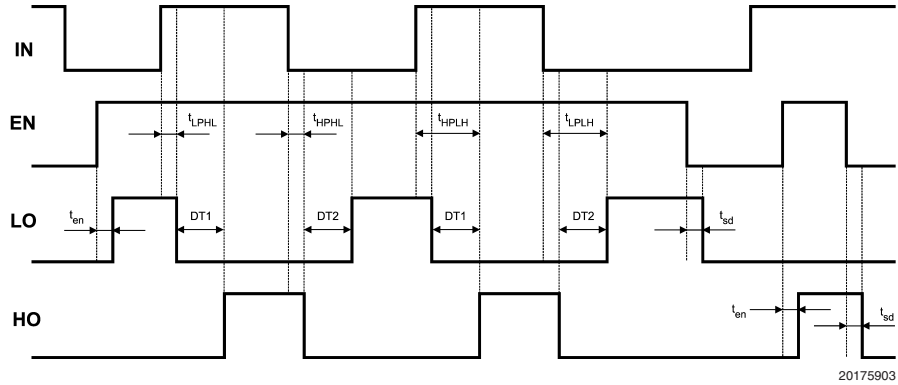

FIGURE 2. LM5106 Input - Output Waveforms

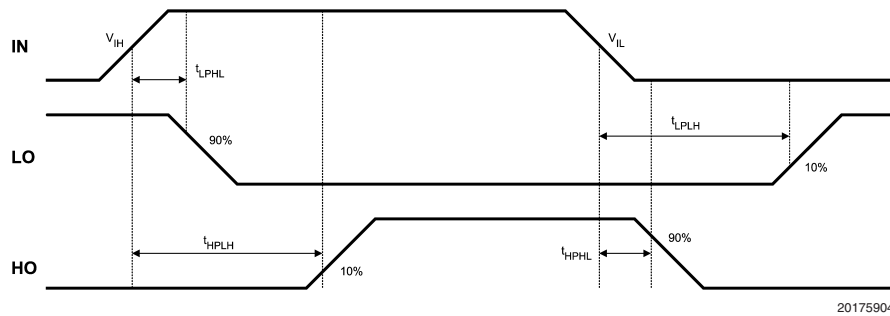

FIGURE 3. LM5106 Switching Time Definitions: t_{LPHL} , t_{LPHL} , t_{HPLH} , t_{HPLH}

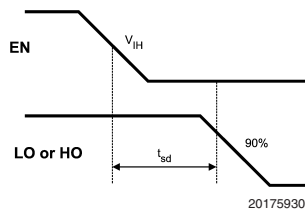

FIGURE 4. LM5106 Enable: t_{sd}

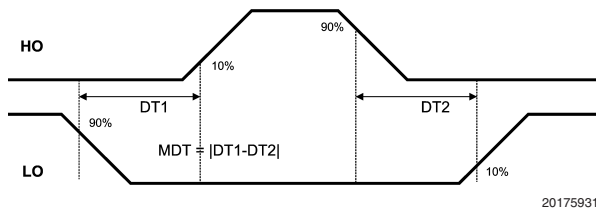

FIGURE 5. LM5106 Dead-time: DT

Operational Notes

The LM5106 is a single PWM input Gate Driver with Enable that offers a programmable dead-time. The dead-time is set with a resistor at the RDT pin and can be adjusted from

100ns to 600ns. The wide dead-time programming range provides the flexibility to optimize drive signal timing for a wide range of MOSFETs and applications.

The RDT pin is biased at 3V and current limited to 1 mA maximum programming current. The time delay generator will accommodate resistor values from 5k to 100k with a dead-time time that is proportional to the RDT resistance. Grounding the RDT pin programs the LM5106 to drive both outputs with minimum dead-time.

STARTUP AND UVLO

Both top and bottom drivers include under-voltage lockout (UVLO) protection circuitry which monitors the supply voltage (V_{DD}) and bootstrap capacitor voltage ($HB - HS$) independently. The UVLO circuit inhibits each driver until sufficient supply voltage is available to turn-on the external MOSFETs, and the UVLO hysteresis prevents chattering during supply voltage transitions. When the supply voltage is applied to the V_{DD} pin of the LM5106, the top and bottom gates are held low until V_{DD} exceeds the UVLO threshold, typically about 6.9V. Any UVLO condition on the bootstrap capacitor will disable only the high side output (HO).

LAYOUT CONSIDERATIONS

The optimum performance of high and low side gate drivers cannot be achieved without taking due considerations during circuit board layout. The following points are emphasized:

Operational Notes (Continued)

- Low ESR / ESL capacitors must be connected close to the IC between VDD and VSS pins and between HB and HS pins to support high peak currents being drawn from VDD and HB during the turn-on of the external MOSFETs.
- To prevent large voltage transients at the drain of the top MOSFET, a low ESR electrolytic capacitor and a good quality ceramic capacitor must be connected between the MOSFET drain and ground (VSS).
- In order to avoid large negative transients on the switch node (HS) pin, the parasitic inductances between the source of the top MOSFET and the drain of the bottom MOSFET (synchronous rectifier) must be minimized.
- Grounding considerations:
 - The first priority in designing grounding connections is to confine the high peak currents that charge and discharge the MOSFET gates to a minimal physical area. This will decrease the loop inductance and minimize noise issues on the gate terminals of the MOSFETs. The gate driver should be placed as close as possible to the MOSFETs.
 - The second consideration is the high current path that includes the bootstrap capacitor, the bootstrap diode, the local ground referenced bypass capacitor, and the low side MOSFET body diode. The bootstrap capacitor is recharged on a cycle-by-cycle basis through the bootstrap diode from the ground referenced VDD bypass capacitor. The recharging occurs in a short time interval and involves high peak current. Minimizing this loop length and area on the circuit board is important to ensure reliable operation.
- The resistor on the RDT pin must be placed very close to the IC and separated from the high current paths to avoid noise coupling to the time delay generator which could disrupt timer operation.

POWER DISSIPATION CONSIDERATIONS

The total IC power dissipation is the sum of the gate driver losses and the bootstrap diode losses. The gate driver losses are related to the switching frequency (f), output load capacitance on LO and HO (C_L), and supply voltage (V_{DD}) and can be roughly calculated as:

$$P_{DGATES} = 2 \cdot f \cdot C_L \cdot V_{DD}^2$$

There are some additional losses in the gate drivers due to the internal CMOS stages used to buffer the LO and HO outputs. The following plot shows the measured gate driver power dissipation versus frequency and load capacitance. At higher frequencies and load capacitance values, the power dissipation is dominated by the power losses driving the output loads and agrees well with the above equation. This plot can be used to approximate the power losses due to the gate drivers.

Gate Driver Power Dissipation (LO + HO)
 $V_{CC} = 12V$

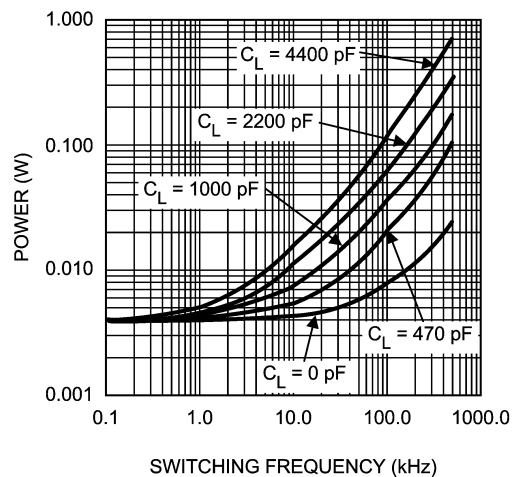

20175905

HS TRANSIENT VOLTAGES BELOW GROUND

The HS node will always be clamped by the body diode of the lower external FET. In some situations, board resistances and inductances can cause the HS node to transiently swing several volts below ground. The HS node can swing below ground provided:

- HS must always be at a lower potential than HO. Pulling HO more than -0.3V below HS can activate parasitic transistors resulting in excessive current flow from the HB supply, possibly resulting in damage to the IC. The same relationship is true with LO and VSS. If necessary, a Schottky diode can be placed externally between HO and HS or LO and GND to protect the IC from this type of transient. The diode must be placed as close to the IC pins as possible in order to be effective.
- HB to HS operating voltage should be 15V or less. Hence, if the HS pin transient voltage is -5V, VDD should be ideally limited to 10V to keep HB to HS below 15V.
- Low ESR bypass capacitors from HB to HS and from VCC to VSS are essential for proper operation. The capacitor should be located at the leads of the IC to minimize series inductance. The peak currents from LO and HO can be quite large. Any inductances in series with the bypass capacitor will cause voltage ringing at the leads of the IC which must be avoided for reliable operation.

Operational Notes (Continued)

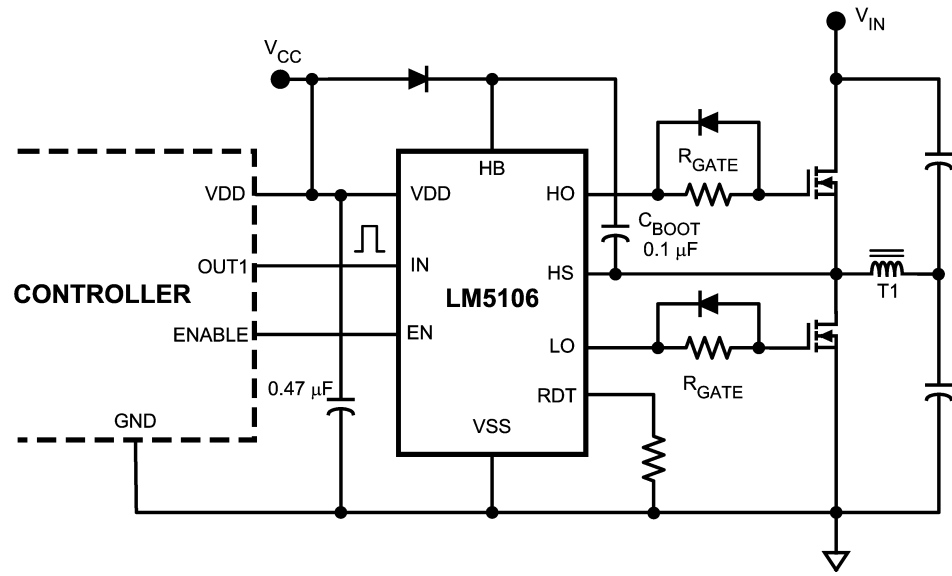

20175908

FIGURE 6. LM5106 Driving MOSFETs Connected in Half-Bridge Configuration

Physical Dimensions inches (millimeters) unless otherwise noted

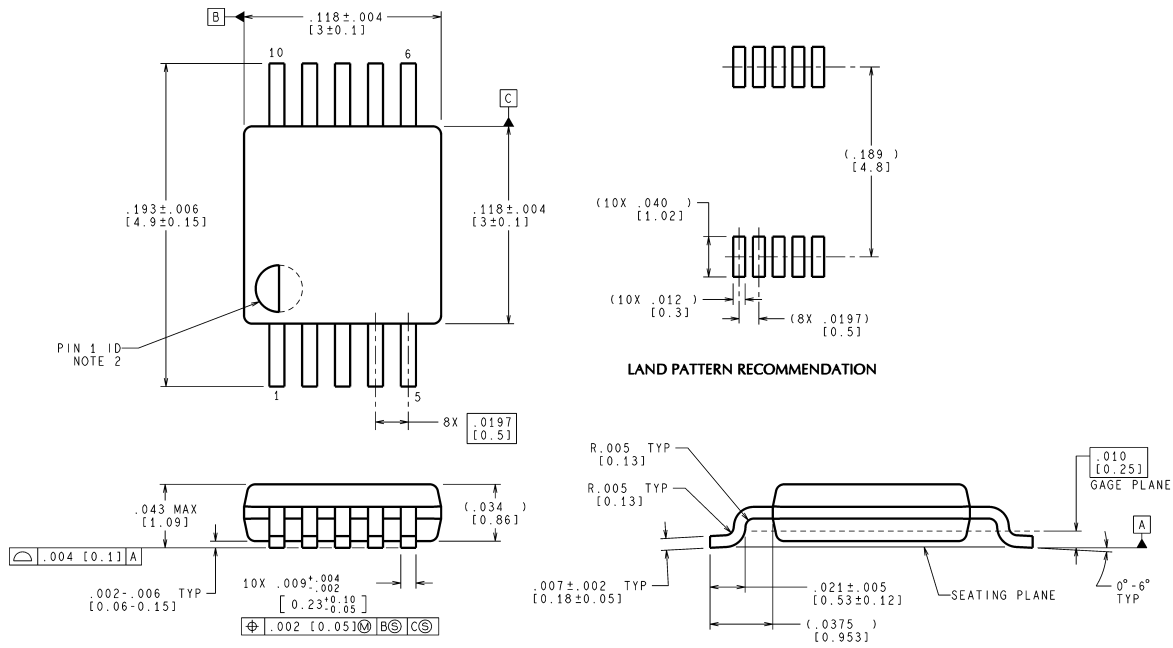

CONTROLLING DIMENSION IS INCH
VALUES IN [] ARE MILLIMETERS
DIMENSIONS IN () FOR REFERENCE ONLY

MUB10A (Rev B)

MSOP-10 Outline Drawing
NS Package Number MUB10A

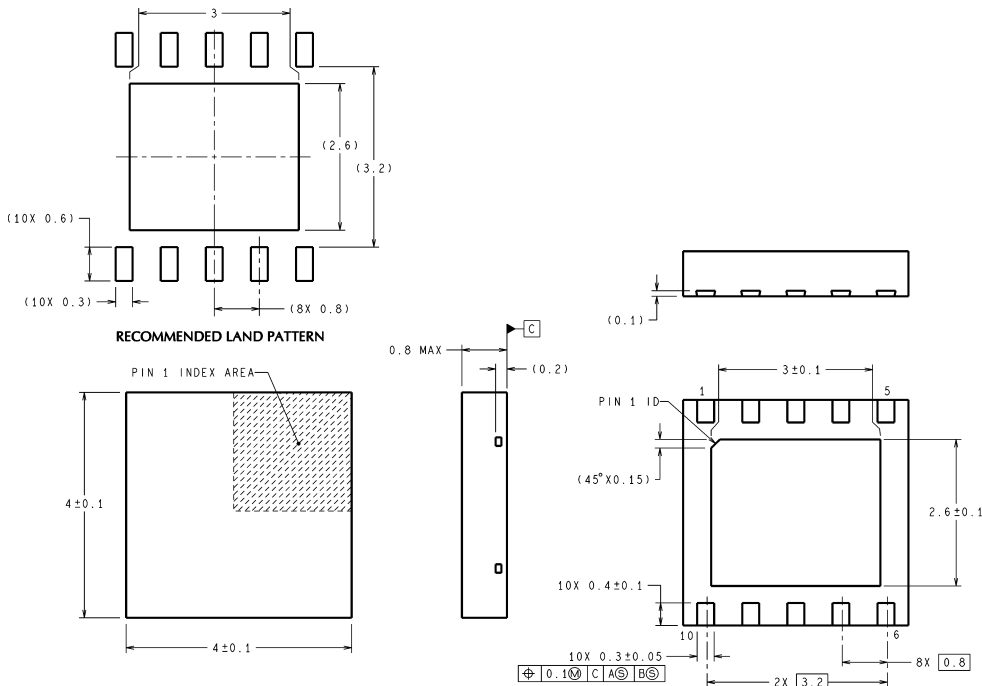

DIMENSIONS ARE IN MILLIMETERS

SDC10A (Rev A)

Notes: Unless otherwise specified

1. Standard lead finish to be 200 microinches/5.00 micrometers minimum tin/lead (solder) on copper.
2. Pin 1 identification to have half of full circle option.
3. No JEDEC registration as of Feb. 2000.

LLP-10 Outline Drawing
NS Package Number SDC10A

Notes

National does not assume any responsibility for use of any circuitry described, no circuit patent licenses are implied and National reserves the right at any time without notice to change said circuitry and specifications.

For the most current product information visit us at www.national.com.

LIFE SUPPORT POLICY

NATIONAL'S PRODUCTS ARE NOT AUTHORIZED FOR USE AS CRITICAL COMPONENTS IN LIFE SUPPORT DEVICES OR SYSTEMS WITHOUT THE EXPRESS WRITTEN APPROVAL OF THE PRESIDENT AND GENERAL COUNSEL OF NATIONAL SEMICONDUCTOR CORPORATION. As used herein:

1. Life support devices or systems are devices or systems which, (a) are intended for surgical implant into the body, or (b) support or sustain life, and whose failure to perform when properly used in accordance with instructions for use provided in the labeling, can be reasonably expected to result in a significant injury to the user.
2. A critical component is any component of a life support device or system whose failure to perform can be reasonably expected to cause the failure of the life support device or system, or to affect its safety or effectiveness.

BANNED SUBSTANCE COMPLIANCE

National Semiconductor follows the provisions of the Product Stewardship Guide for Customers (CSP-9-111C2) and Banned Substances and Materials of Interest Specification (CSP-9-111S2) for regulatory environmental compliance. Details may be found at: www.national.com/quality/green.

Lead free products are RoHS compliant.



National Semiconductor
Americas Customer
Support Center
Email: new.feedback@nsc.com
Tel: 1-800-272-9959

www.national.com

National Semiconductor
Europe Customer Support Center
Fax: +49 (0) 180-530 85 86
Email: europa.support@nsc.com
Deutsch Tel: +49 (0) 69 9508 6208
English Tel: +44 (0) 870 24 0 2171
Français Tel: +33 (0) 1 41 91 8790

National Semiconductor
Asia Pacific Customer
Support Center
Email: ap.support@nsc.com

National Semiconductor
Japan Customer Support Center
Fax: 81-3-5639-7507
Email: jpn.feedback@nsc.com
Tel: 81-3-5639-7560